

*Crane Scale*

# **CASTON III**

**OWNER'S MANUAL**



9007-CT3-0033-1

2004.5

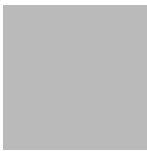

## CONTENTS



|                                     |    |
|-------------------------------------|----|
| PRECAUTIONS .....                   | 4  |
| PREFACE .....                       | 7  |
| NAMES AND FUNCTIONS .....           | 7  |
| BATTERY USAGE .....                 | 9  |
| OPERATION .....                     | 10 |
| FUNCTIONS & DESCRIPTIONS .....      | 10 |
| 1. ZERO FUNCTION .....              | 10 |
| 2. TARE FUNCTION .....              | 11 |
| 3. HOLD FUNCTION .....              | 11 |
| 4. FUNCTION OF REMOTE CONTROL ..... | 11 |
| USE OF BATTERY CHARGER .....        | 12 |
| SPECIFICATIONS .....                | 12 |
| PRODUCT SIZE .....                  | 13 |

## PRECAUTIONS

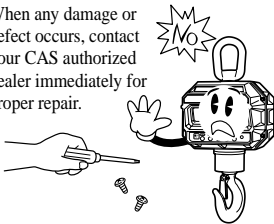
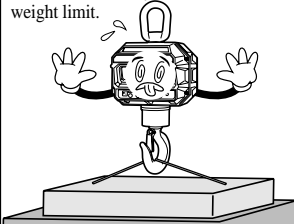
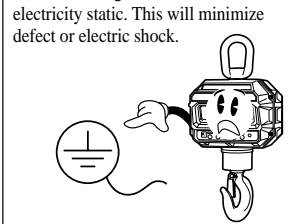
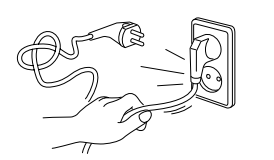
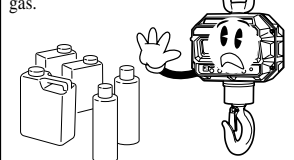
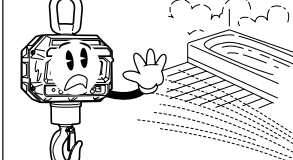
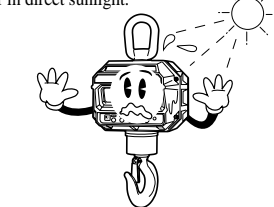
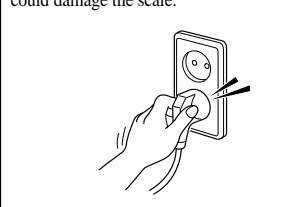
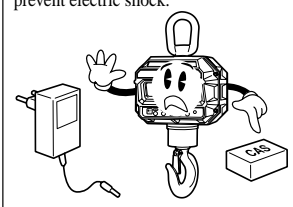
To installate, safety pin in hook should be fixed to prevent dropping out from lift eye bolt.

| ! Warning  |  |   |
|--|--|---|
| <p>Do not disassemble the scale. When any damage or defect occurs, contact your CAS authorized dealer immediately for proper repair.</p>  | <p>Do not overload beyond the maximum weight limit.</p>   | <p>Scale must be grounded to minimize electricity static. This will minimize defect or electric shock.</p>              |
| <p>Do not pull the plug by its cord when unplugging. Damaged cord could cause electric shock or fire.</p>                                | <p>To prevent from fire occurring. Do not place or use the scale near flammable or corrosive gas.</p>  | <p>To reduce electric shock or incorrect reading. Do not spill water on the scale or place it in humid condition.</p>  |
| <p>Avoid placing the scale near heater or in direct sunlight.</p>   | <p>Use proper Adapter. Incorrect adapter could damage the scale.</p>                                  | <p>Insert plug firmly to wall outlet to prevent electric shock.</p>   |

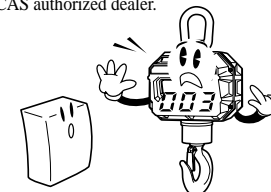
Do not stand under the scale while weighing the load, and you should be careful to provide against a safety accident.

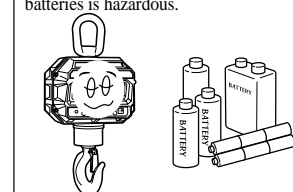
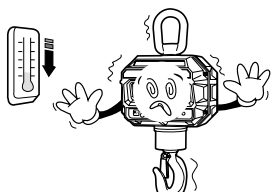
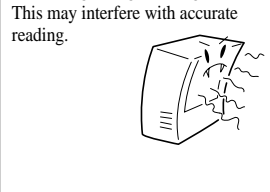
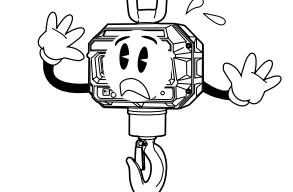
| ! Attention  |  |  |
|--|--|--|
| <p>For consistent and accurate reading, maintain periodical check by your CAS authorized dealer.</p>  | <p>Avoid sudden shock to the scale. Internal mechanism could be damaged.</p>    | <p>Take the battery out when scale is not in use for long time. Leakage from the batteries is hazardous.</p>  |
| <p>Place the scale on firm and temperature consistent environment.</p>                               | <p>Keep the scale away from other electromagnetic generating devices. This may interfere with accurate reading.</p>  |    |

If you don't use the scale for a long time, you should turn off POWER S/W on the rare panel.



**WARNING** : The load which hang on the hook should be a vertical load. (Refer to the next features)

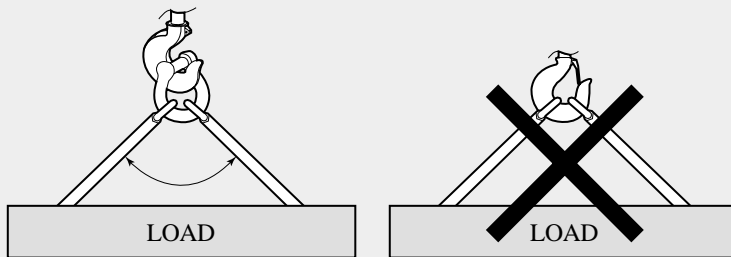

■ The load which hang on the hook should be a vertical load.

## PREFACE

We greatly appreciate your purchase of the CASTON- III. These goods perform excellently and exhibit splendid properties through strike tests. The CASTON- III is delicately designed to coincide with the special requirements of several industrial fields and includes many functions and various external interfaces. Also, it is programmed for the user's convenience and contains display functions that are easily accessible. Before using The CASTON- III, it is recommended that you read this manual carefully so you may use this device to its full potential.

## NAMES AND FUNCTIONS

### OVERALL VIEW

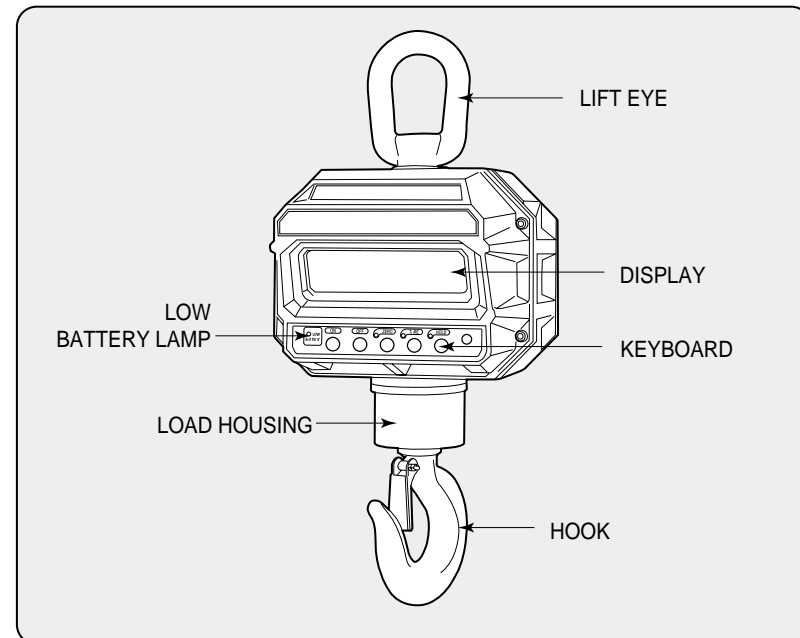

## DISPLAY & KEYBOARD

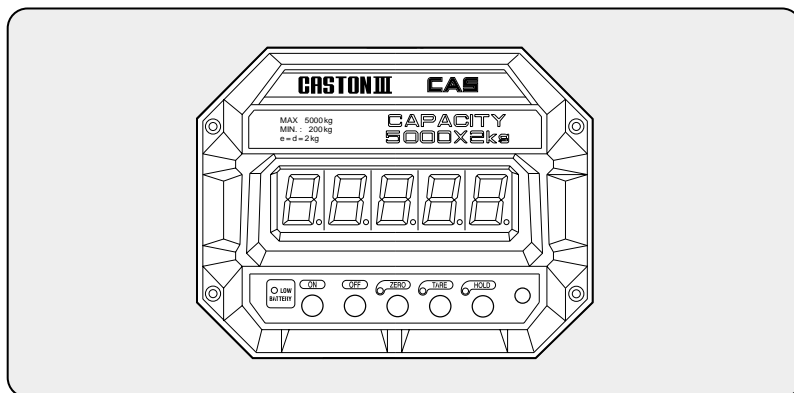

### ■ DISPLAY

**WEIGHT DISPLAY:** Displays weight or messages.

**ZERO LAMP:** Indicates that scale is stable and at zero.

**TARE LAMP:** Indicates that scale is currently using a tare.

**HOLD LAMP:** Indicates that the HOLD feature has been activated.

**LOW BATTERY LAMP:** Indicates that battery is low and must be changed soon.

### ■ KEY FUNCTIONS

| KEYS        | FUNCTIONS  |
|-------------|--|
| <b>ON</b>   | Used to turn the scale ON.                               |
| <b>OFF</b>  | Used to turn the scale OFF.                              |
| <b>ZERO</b> | Resets scale to zero.                                    |
| <b>TARE</b> | Used to enter tare weight and to clear tare entry.       |
| <b>HOLD</b> | Used to weigh unstable things.(Liquids, Livestock, etc.) |

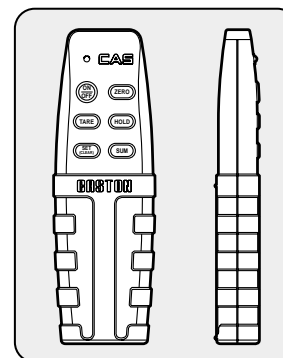

## Remote Control

- **ON/OFF:** Does not turn scale OFF, only saves power by pausing display.
- **ZERO:** Same as keyboard.
- **TARE:** Same as keyboard.
- **HOLD:** Same as keyboard.
- **SET(CLEAR):** Used to clear previously added weight.
- **SUM:** Used to add weight.

► **NOTE:** To cut power completely from scale, you must use main power switch on rear of scale.

## BATTERY USAGE

- Open the battery lid located in back of the scale and turn main power switch off.
- Separate the battery connector and take out the discharged battery.
- Put a charged battery in rear and connect the battery connector.  
Turn main power switch on and cover the battery lid.

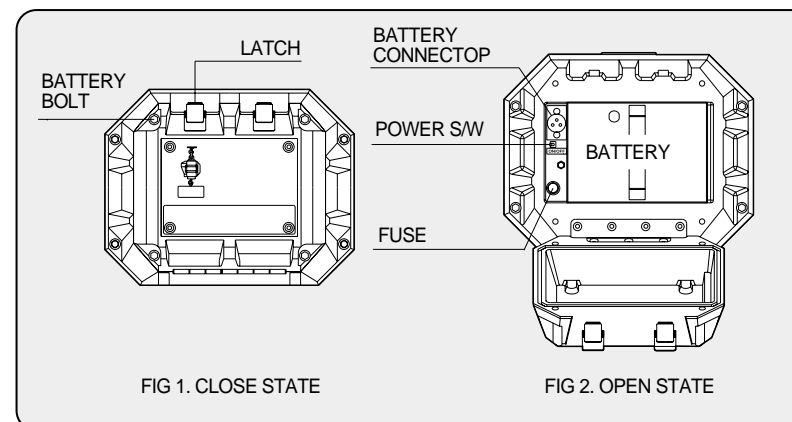

## OPERATION

- Press the **ON** key located in front of the scale.  
The scale will perform self test on the WEIGHT DISPLAY and will be ready for weighing when zero lamp is on.  
(While the power is off, the **ON/OFF** key on the remote control wouldn't operate.)
- Use the **ON/OFF** key on the remote controller when the power is on.  
Hook should be empty.

## FUNCTIONS & DESCRIPTIONS

### 1. ZERO FUNCTION

- Used to correct drifted zero value when the scale is unloaded  
(You can adjust the zero up to  $\pm 2\%$  of the maximum capacity),  
and motion is not detected.
- The function works when **ZERO** key is pressed, and the ZERO LAMP is on.
- Example: If the weight has drifted, you can press **ZERO** key to bring back to the zero. 20kg on weight display will go to 0kg when you press the **ZERO** key.

### 2. TARE FUNCTION

- Tare is the weight of container being used for a commodity.  
The **TARE** key subtracts the weight of the container.
- After hanging a weight to be tared on the HOOK, press the **TARE** key.  
Then the scale will memorize the weight of the tare and will display zero value "0"kg. The TARE lamp will be on.
- If you weigh items, you will see the net weight.
- To release this function, remove everything from the hook and press the **TARE** key.  
Then the TARE LAMP will turn off and this function is terminated.

► NOTE: The weight including TARE weight can't exceed the maximum capacity.

### 3. HOLD FUNCTION

#### Automatic Hold Function

(This function is performed whenever you weigh an item)

- Press the **HOLD** key when the hook is empty. (In zero value condition)
- The Weight Display will display "HOLD ON" sequentially.
- The scale will change from the Normal mode to Auto-hold mode, and HOLD lamp will turn on.
- If you weigh unstable things in Auto-hold mode, "Hold" will display on the Weight Display. And then, the average value of the weight fluctuation will display.
- The weight will remain on display even if the weight is removed.  
To delete holded value, press the **HOLD** key again.
- To escape from Auto-hold mode, press the **HOLD** key when the hook is empty.  
The message "HOLD OFF" will be displayed and HOLD lamp turning off.

#### Manual Hold Function (Execute when you press HOLD key)

- Press the **HOLD** key while weighing an unstable item.  
"Hold" will display and then, the average value of the weight fluctuation will display on the Weight Display.
- To escape from this mode, press the **HOLD** key again.  
Then the scale changes from Hold mode to Normal mode.

### 4. FUNCTION OF REMOTE CONTROL

- Key functions of remote control are the same as those of the scale key board.
- **SUM FUNCTION**: Press **SUM** key when a thing is hang on the hook in weighing mode. Then the scale will change weighing mode to sum mode and will add old and new weights. This added weighing value will be memorized and displayed on the WEIGHT DISPLAY.
- To clear the added weights, press **SUM** key in weighing mode, and the scale will change to sum mode.
- Press **SET(CLEAR)** key, and then the scale will clear the added weights.
- To escape from this sum mode, press **SUM** key again.

## USE OF BATTERY CHARGER

- Check the voltage of battery charger before use.  
(It is fixed to 220V before shipping.)
- Insert charger A.C cord into the power source and connect the discharged battery to the connector.
- Turn ON the switch on the battery charger, charging will start with RED lamp (CHARG) turn on.
- When the charging is completed, GREEN lamp (FULL) turns on.
- Estimated time for charging is 8 hours.  
(Charging time can be vary according to the battery condition.)

## SPECIFICATIONS

| MODEL             | CASTON III                         |
|-------------------|------------------------------------|
| MAX. TARE WEIGHT  | FULL TARE                          |
| DISPLAY           | L.E.D(1.5 inch)                    |
| TEMPERATURE RANGE | -10°C ~40°C                        |
| POWER SOURCE      | DC 12V                             |
| BATTERY LIFE TIME | MAXIMUM 40H                        |
| POWER CONSUMPTION | Approx 1.2W                        |
| DISPLAY LAMP      | ZERO, TARE, HOLD, LOW BATTERY LAMP |

| REMOTE CONTROL     |                 |
|--------------------|-----------------|
| AVAILABLE DISTANCE | 6m ~ 10m        |
| AVAILABLE ANGLE    | 60°             |
| POWER              | 3V(1.5V AMM ×2) |

## PRODUCT SIZE

### CASTON III SIZE(0.5 TON ~5 TON)

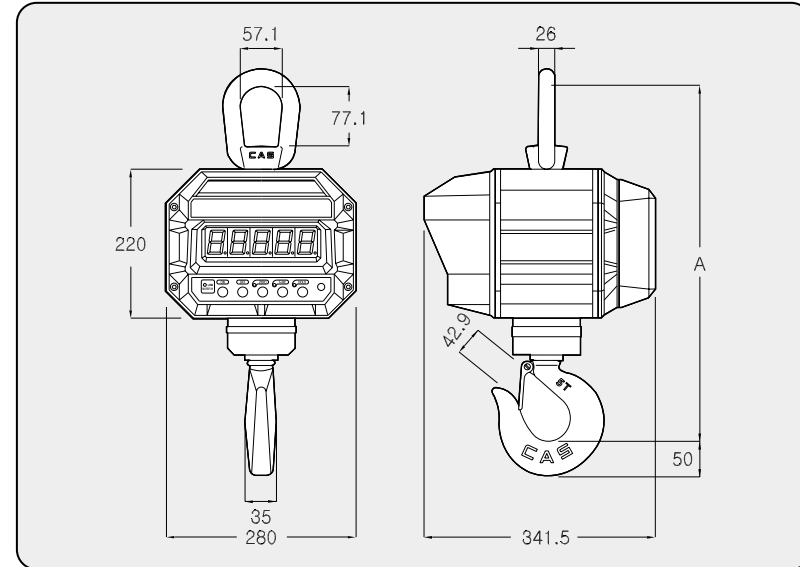

(UNIT: mm)

| MODEL  | MAX.CAPA | DIVISION | A   | WEIGHT |
|--------|----------|----------|-----|--------|
| 0.5THD | 0.5TON   | 200g     | 510 | 26kg   |
| 1THD   | 1TON     | 500g     | 510 | 26kg   |
| 2THD   | 2TON     | 1kg      | 515 | 28kg   |
| 3THD   | 3TON     | 2kg      | 515 | 28kg   |
| 5THD   | 5TON     | 2kg      | 538 | 31kg   |

### CASTON III SIZE (10 TON ~50 TON)

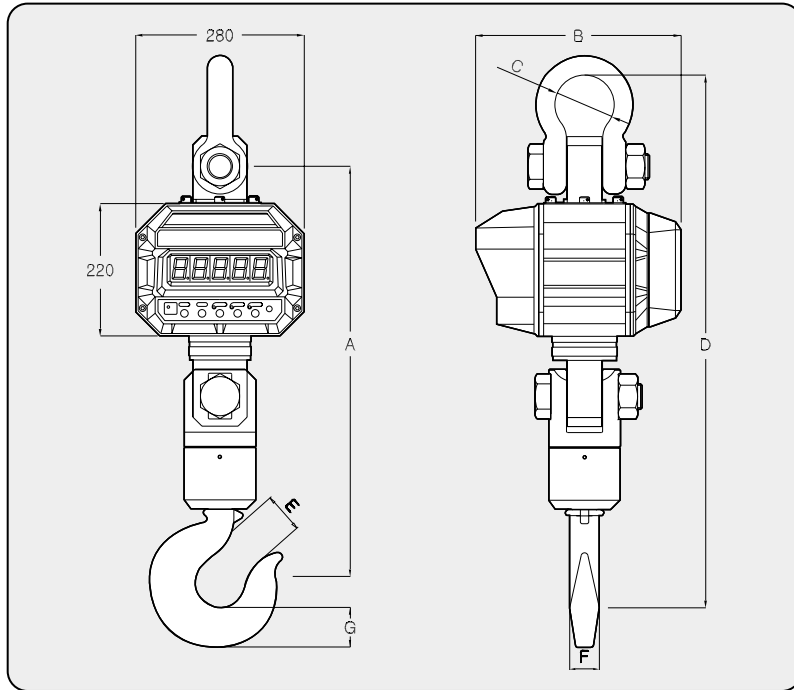

(UNIT: mm)

| MODEL | MAX.CAPA | DIVISION | A    | B   | C    | D    | E    | F     | G    | WEIGHT |
|-------|----------|----------|------|-----|------|------|------|-------|------|--------|
| 10THD | 10TON    | 5kg      | 667  | 360 | ∅83  | 845  | 57.2 | 42    | 57.2 | 44kg   |
| 15THD | 15TON    | 10kg     | 682  | 360 | ∅99  | 886  | 63.5 | 50    | 63.5 | 53kg   |
| 20THD | 20TON    | 10kg     | 725  | 360 | ∅126 | 990  | 86   | 60    | 86   | 76kg   |
| 30THD | 30TON    | 20kg     | 895  | 440 | ∅138 | 1200 | 108  | 92    | 108  | 220kg  |
| 50THD | 50TON    | 20kg     | 1400 | 440 | ∅180 | 1520 | 146  | 112.7 | 146  | 390kg  |

► Notice : Specifications are subject to change for improvement without notice.